

nextlight **PLUS**
PRO SERIES



USER MANUAL

Thank you for choosing



Table of Contents

1. NextLight Plus Pro	1	7. Product Installation	4
2. Safety Recommendations and Warnings ..	2	8. Use with a Controller	5
3. Package Contents	2	9. Connecting Multiple Fixtures	5
4. Technical Specifications	3	10. Proper Use and General Care	6
5. Product Dimensions	3	11. NextLight Support	6
6. Driver Connections	3	12. Manufacturer's Warranty	6



WARNING: Please read and follow the instructions before installing and using your *NextLight Plus Pro*.

1. NextLight Plus Pro - 320W LED Grow Light

- 2.6 PPF/W ($\mu\text{mol}/\text{J}$)
- DLC Hort Listed
- UL 8800
- IP65 Wet Rated
- 5 Year Limited Warranty
- Passively Cooled
- Designed for supplemental greenhouse and various indoor applications
- External Dimming (**Controller NOT INCLUDED**)
- **NextLight's Full Spectrum** is recommended from seed to harvest
- Plug & Play - contains power & dimming cords, power supply and mounting hardware

The *NextLight Plus Pro* is a high efficiency - bright white LED grow light designed for supplemental greenhouse use. The thin profile design minimizes shadows in the greenhouse and can also be used in various indoor applications.

At a lower operating cost than traditional technology, *NextLight Plus Pro* ensures vigorous production throughout the entire year, without bulb changes and maintenance.

If you still have questions, please visit blazinled.com

2. Safety Recommendations and Warnings



WARNING: Please read and follow all Safety Recommendations and Warnings before installing your **NextLight Plus Pro**.

- Please check and adhere to all local rules, regulations and zoning codes when installing.
- The installer is responsible for correct and safe installation of light system.
- Prevent eye damage by avoiding direct eye contact with LEDs.
- Operate the light system within the temperature range of -4°F and 104°F.
- Mount the light system to something that can support the weight of the Fixture and Driver.
- Always allow for adequate ventilation of light system. Minimum 3" from walls/ceiling.
- **Do NOT** hang Fixture or Driver by Power Cords.
- Ensure the local cabling can support the voltage and current of the light system.
- Only use Power Cords that were supplied with your light system.
- **Do NOT** use the Fixture or Driver with damaged Power Cords.
- **Do NOT** plug in AC power prior to connecting the Fixture to the Driver.
- **Do NOT** connect or disconnect the Fixture from the Driver under load.
- **Do NOT** attempt to open, rewire or reconfigure any components of the light system. It will void the warranty and could cause serious injury or death.
- Disconnect the light system from power before performing any maintenance or repairs.
- Always disconnect power from the light system before moving or cleaning it.
- **Do NOT** clean the light system with detergents, abrasives or other aggressive substances.
- **Do NOT** use the light system near flammable, explosive or reactive substances.
- **Do NOT** use any Volatile Organic Compounds (VOCs) on or near the light system. VOCs can cause damage to LEDs (including insect foggers).
- The light system is certified for use in damp locations and is protected against water projected from a nozzle. **Do NOT** submerge light system.
- Avoid any contact or force with LED array that may damage LEDs.

3. Package Contents

- 1 Fixture with Attached DC Out Power Cord (2') **x1**
- 2 Driver **x1**
- 3 Fixture Hooks **x2**
- 4 Driver Hooks **x2**
- 5 NextLight Pro Series Power Cord (10') **x1**
*(see available **Power Cord Voltage Options**)*
- 6 NextLight Pro Series Control Cable (20') **x1**

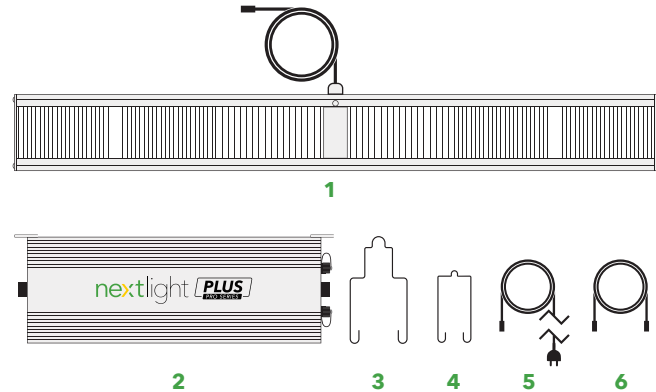

Power Cord Voltage Options



120V
(NEMA 5-15P)



240V
(NEMA 6-15P)



277V
(TWIST LOCK)



277V
(OPEN-END/WHIP)

4. Technical Specifications

SPECIFICATION	NEXTLIGHT PLUS PRO
Operating Voltage	120-277 VAC
Operating Frequency	50/60 Hz
Input Current	2.67A @ 120V, 1.34A @ 240V, 1.16A @ 277V
PPF	800
Energy Use	320 Watts (305W @ 277V)
PPF/Watt	2.6
Operating Temperature	-4°F to 104°F (-20°C to 40°C)
BTU Output	1100
Fixture Dimensions (in/mm)	28.75 x 3.5 x 4.5 / 726.7 x 85.9 x 111.7
Driver Dimensions (in/mm)	14.75 x 5 x 2.25 / 374 x 124.4 x 54.5
Weight	17 lbs (7.71 kg)
Warranty	5 Year Limited
Life Rating	Q90 > 50,000 Hours
Certifications	DLC Hort, CE, UL 8800
Environment	IP65, Wet Rated

5. Product Dimensions

Fixture Dimensions

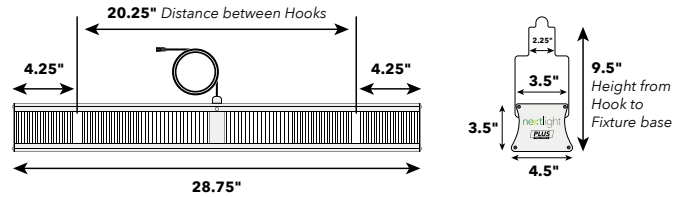

Driver Dimensions

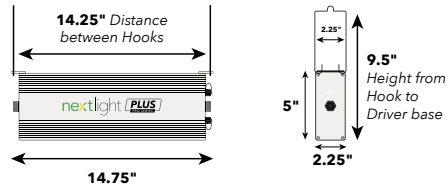

6. Driver Connections

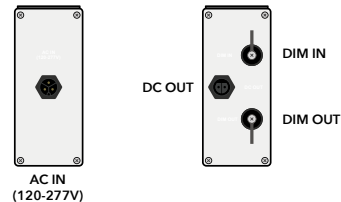

7. Product Installation

- 1 • Hang both Fixture Hooks over the support structure.
• Lift Fixture into place.
• Insert Hook ends in designated Heat Sink Fin Gaps. Designated Gaps are approximately 4.25" from Fixture ends.

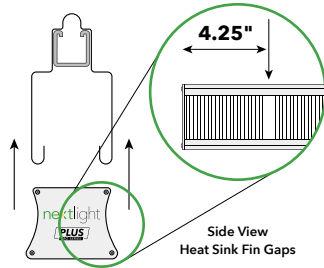

Side View
Heat Sink Fin Gaps

- 2 • Hang both Driver Hooks over the support structure.
• Lift Driver into place.
• Insert Hook ends through holes on Driver Hanging Bracket at ends of Driver.

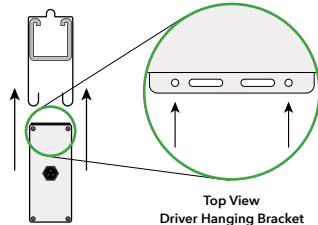

Top View
Driver Hanging Bracket

- 3 • Mount the Fixture in a location based on your lighting needs.
• Mount the Driver adjacent to the Fixture to allow ease of power connection.

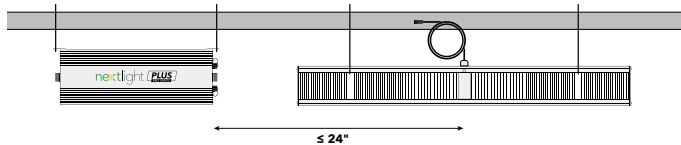

- 4 • Connect the attached DC Out Power Cord to the DC Out on the Driver.

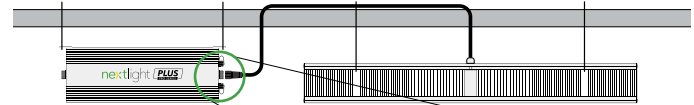

- Insert DC Out Power Cord into DC Out connection until an audible click is heard to ensure proper connection.
• To remove connection, twist the locking ring counter clockwise and pull.



Side View
Driver DC OUT

- 5 • Connect the **NextLight Pro Series Power Cord** to the AC In on the Driver.

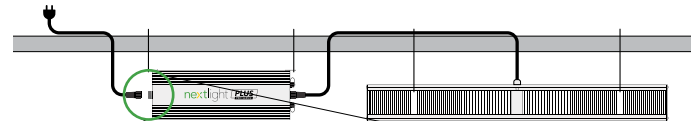

- Insert Power Cord into AC In connection until an audible click is heard to ensure proper connection.
• To remove connection, twist the locking ring counter clockwise and pull.

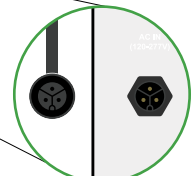

Side View
Driver AC IN

8. Use with a Controller

To enable Dimming Control and Programming on your **NextLight Plus Pro**, you will need either a **NextLight Control Pro** or **NextLight Adapt Pro**.

A. NextLight Control Pro enables Dimming Control, On/Off Timing, Sunrise/Sunset Programming and more. The **NextLight Control Pro** can control up to 500 **NextLight Pro Series** fixtures per controller (250 per Channel).

NextLight Control Pro Lighting System Chain

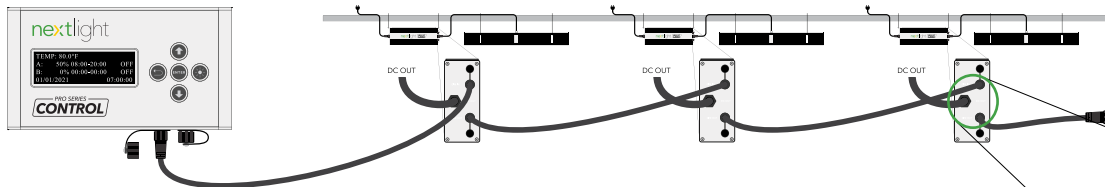

B. NextLight Adapt Pro enables integration with most third party 0-10V controllers. This product adapts your third party 0-10V signal to **NextLight's** proprietary signal flow.

NextLight Adapt Pro Lighting System Chain

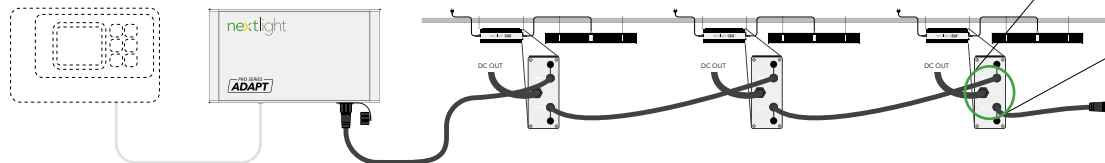

9. Connecting Multiple Fixtures

- Insert **NextLight Pro Series Control Cable** into Channel A/B of your **NextLight Control Pro** or 485 Output of your **NextLight Adapt Pro**. Then screw the locking ring clockwise to ensure proper connection.
- Insert other end of Control Cable into Dim In connection on Driver of first Fixture in lighting system chain.
- Connect Control Cable from Dim Out on Driver of first Fixture to Dim In on Driver of next Fixture in the lighting system chain.
- Repeat until all Drivers/Fixtures are connected.

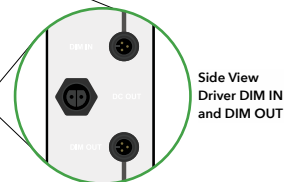

Side View
Driver DIM IN
and DIM OUT

10. Proper Use and General Care

Follow steps below to help your light system retain peak performance.

- Hang Fixture using supplied Fixture Hooks.
- Hang Fixture at a minimum of 24" from bottom of Fixture to top of plant canopy. Less than 24" distance may burn plants.
- Always allow for adequate ventilation of Fixtures to ensure your lighting system can properly cool. Failure to do so may shorten the lighting system's lifespan.
- Wipe down outside of Fixture with a damp rag. Dry thoroughly with a chamois or moist cellulose sponge to prevent water spots. All cleaning should be done with the light system unplugged from its power source.
- Avoid touching diodes with your hands, even if powered off.
- Never clean light system with detergents or abrasives.

11. NextLight Support

Please visit blazinled.com for support.

12. Five (5) Year Limited Warranty



Please visit blazinled.com for warranty information.

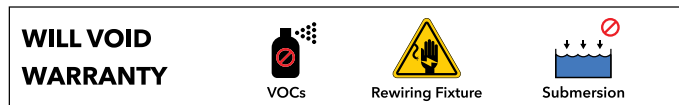

This product is for horticulture use only.
Not suitable for room illumination.

Legal Disclaimer

NextLight products are to be used for lawful purposes only. It is the responsibility of you as the purchaser to know and abide by all laws pertaining to the use of *NextLight* products. **BlazinLED** will NOT be held liable for any unlawful state or federal activity arising out of the use of our products. By purchasing a *NextLight* product, you are agreeing to these terms and conditions, confirming that you as the purchaser are attesting to the lawful use of our product and are thereby solely responsible for acting in conformance with all applicable regulations.

Thank you for choosing

nextlight

blazinled.com

